

Technical data sheet

Product features



Display unit chilled GN 6-1/1 - 150 mm drop-in

Model	SAP Code	00012051
--------------	-----------------	----------



- Buffet type: BLUE - cooled, dynamic cooling
- Device properties: Chilled
- Number of GN / EN: 6
- GN / EN size in device: GN 1/1
- GN device depth: 200
- Minimum device temperature [°C]: 4
- Maximum device temperature [°C]: 8

SAP Code	00012051	Loading	230 V / 1N - 50 Hz
Net Width [mm]	2144	Number of GN / EN	6
Net Depth [mm]	760	GN / EN size in device	GN 1/1
Net Height [mm]	410	GN device depth	200
Net Weight [kg]	131.20	Minimum device temperature [°C]	4
Power electric [kW]	0.494	Maximum device temperature [°C]	8

Technical data sheet

Technical drawing



Display unit chilled GN 6-1/1 - 150 mm drop-in

Model

SAP Code

00012051

A= ELECTRICAL CONNECTION
 D= WATER DISCHARGE Ø16
 E= GAS CONNECTION Ø8 Ø10
 F= WATER BOX

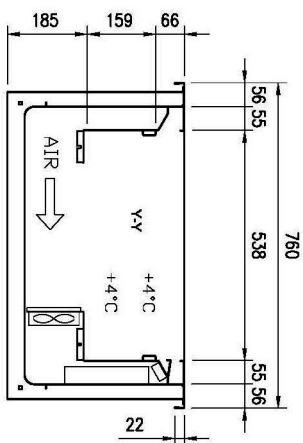
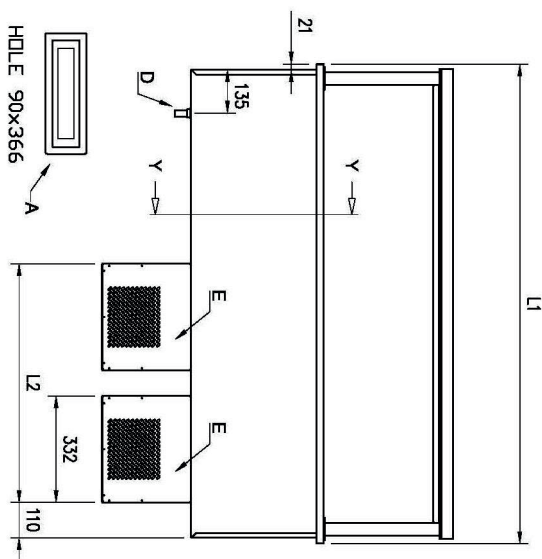
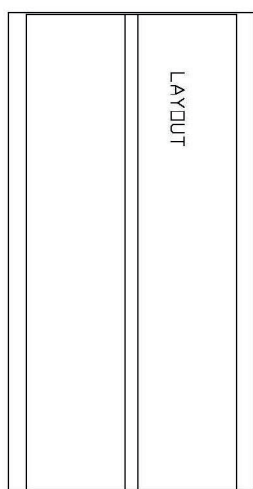

GN	L1	L2	HOLE
4/1	1494	744	1460x726
5/1	1819	744	1785x726
6/1	2144	1059	2110x726

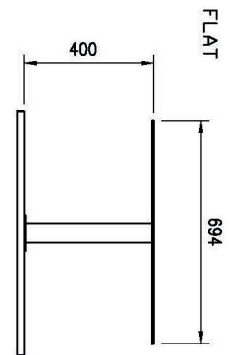
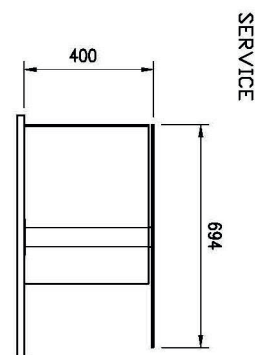
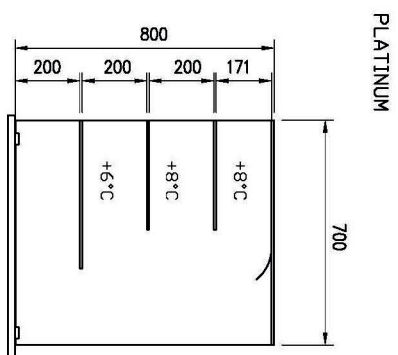
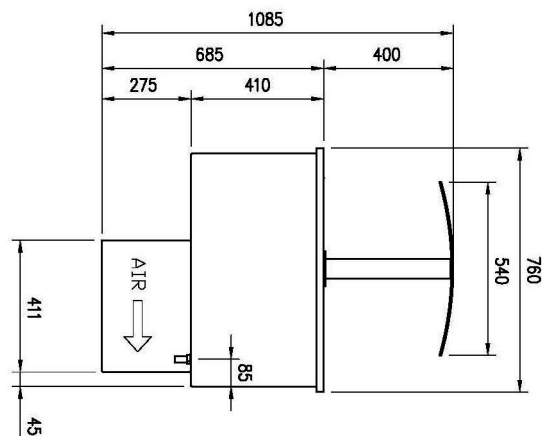

Technical data sheet

Product benefits



Display unit chilled GN 6-1/1 - 150 mm drop-in

Model

SAP Code

00012051

1

Built-in

the possibility to plant in a dispensing block design

- unified design of the dispensing line
- a luxurious look that customers appreciate

2

Dynamic cooling

constant temperature in all places of the refrigerated space

- greater hygienic safety of chilled food

3

GN insertion up to 200mm

variability of use

- possibility of cooling different types of food and larger volumes
- saving time, space, costs

4

Rounded corners

basins without sharp edges and corners

- higher hygienic safety
- time saving due to easy cleaning

5

Removable evaporator filter

basins without sharp edges and corners

- time saving for cleaning

6

All-stainless steel construction

harmless to health for contact with food
robustness

- long service life
- very easy to clean

7

One large bathtub

one controller for the whole basin

- very easy to use
- easy maintenance

Technical data sheet

Technical parameters



Display unit chilled GN 6-1/1 - 150 mm drop-in

Model

SAP Code

00012051

1. SAP Code:

00012051

2. Net Width [mm]:

2144

3. Net Depth [mm]:

760

4. Net Height [mm]:

410

5. Net Weight [kg]:

131.20

6. Gross Width [mm]:

2208

7. Gross depth [mm]:

1012

8. Gross Height [mm]:

1000

9. Gross Weight [kg]:

159.00

10. Device type:

Electric unit

11. Material:

AISI 304

12. Buffet type:

BLUE - cooled, dynamic cooling

13. Device properties:

Chilled

14. Device color:

Stainless steel

15. Power electric [kW]:

0.494

16. Loading:

230 V / 1N - 50 Hz

17. Number of GN / EN:

6

18. GN / EN size in device:

GN 1/1

19. GN device depth:

200

20. Minimum device temperature [°C]:

4

21. Maximum device temperature [°C]:

8